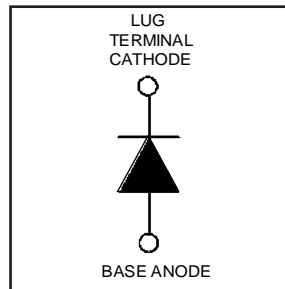


# HFA90NH40R

Ultrafast, Soft Recovery Diode

## Features

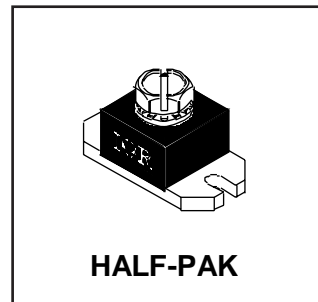
- Reduced RFI and EMI
- Reduced Snubbing
- Extensive Characterization of Recovery Parameters



$V_R = 400V$
$V_F(\text{typ.})^{\textcircled{3}} = 1V$
$I_{F(AV)} = 90A$
$Q_{rr}(\text{typ.}) = 420nC$
$I_{RRM}(\text{typ.}) = 9.3A$
$t_{rr}(\text{typ.}) = 36ns$
$di_{(rec)}/dt(\text{typ.})^{\textcircled{3}} = 260A/\mu s$

## Description

HEXFRED™ diodes are optimized to reduce losses and EMI/RFI in high frequency power conditioning systems. An extensive characterization of the recovery behavior for different values of current, temperature and di/dt simplifies the calculations of losses in the operating conditions. The softness of the recovery eliminates the need for a snubber in most applications. These devices are ideally suited for power converters, motors drives and other applications where switching losses are significant portion of the total losses.



## Absolute Maximum Ratings (per Leg)

	Parameter	Max.	Units
$V_R$	Cathode-to-Anode Voltage	400	V
$I_F @ T_C = 25^\circ C$	Continuous Forward Current	148	A
$I_F @ T_C = 100^\circ C$	Continuous Forward Current	72	
$I_{FSM}$	Single Pulse Forward Current <sup>①</sup>	600	
$E_{AS}$	Non-Repetitive Avalanche Energy <sup>②</sup>	1.4	mJ
$P_D @ T_C = 25^\circ C$	Maximum Power Dissipation	260	W
$P_D @ T_C = 100^\circ C$	Maximum Power Dissipation	104	
$T_J$ $T_{STG}$	Operating Junction and Storage Temperature Range	-55 to +150	°C

## Thermal - Mechanical Characteristics

	Parameter	Min.	Typ.	Max.	Units
$R_{thJC}$	Junction-to-Case	—	—	0.48	°C/W
$R_{thCS}$	Case-to-Sink, Flat, Greased Surface	—	0.15	—	K/W
Wt	Weight	—	26 (0.9)	—	g (oz)
	Mounting Torque <sup>④</sup>	15 (1.7)	—	25 (2.8)	lbf•in
	Terminal Torque	30 (3.4)	—	40 (4.6)	(N•m)
	Vertical Pull	—	—	80	lbf•in
	2 inch Lever Pull	—	—	40	

**Note:** <sup>①</sup> Limited by junction temperature  
<sup>②</sup> L = 100μH, duty cycle limited by max  $T_J$   
<sup>③</sup> 125°C

<sup>④</sup> Mounting surface must be smooth, flat, free of burrs or other protrusions. Apply a thin even film of thermal grease to mounting surface. Gradually tighten each mounting bolt in 5-10 lbf•in steps until desired or maximum torque limits are reached. Module

# HFA90NH40R

PD-2.469 rev. B 02/99

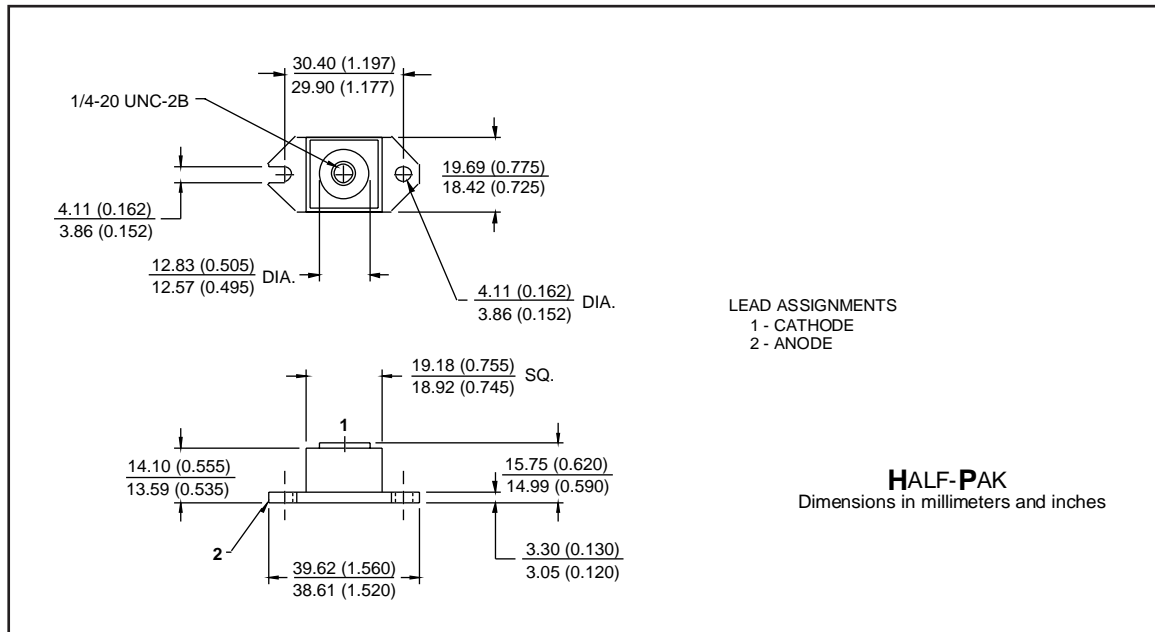
International  
**IOR** Rectifier

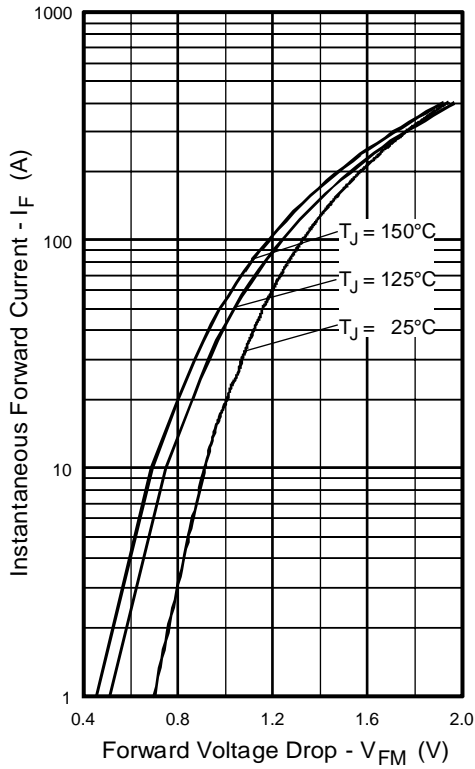
## Electrical Characteristics (per Leg) @ $T_J = 25^\circ\text{C}$ (unless otherwise specified)

Parameter	Min.	Typ.	Max.	Units	Test Conditions
$V_{BR}$ Cathode Anode Breakdown Voltage	400	—	—	V	$I_R = 100\mu\text{A}$
$V_{FM}$ Max Forward Voltage See Fig. 1	—	1.1	1.3	V	$I_F = 90\text{A}$
	—	1.3	1.5		$I_F = 180\text{A}$
	—	1.0	1.2		$I_F = 90\text{A}, T_J = 125^\circ\text{C}$
$I_{RM}$ Max Reverse Leakage Current See Fig. 2	—	1.0	6.0	$\mu\text{A}$	$V_R = V_R \text{ Rated}$
	—	1.5	8.0	$\text{mA}$	$T_J = 125^\circ\text{C}, V_R = 400\text{V}$
$C_T$ Junction Capacitance See Fig. 3	—	180	260	$\text{pF}$	$V_R = 200\text{V}$
$L_S$ Series Inductance	—	7.0	—	$\text{nH}$	From top of terminal hole to mounting plane

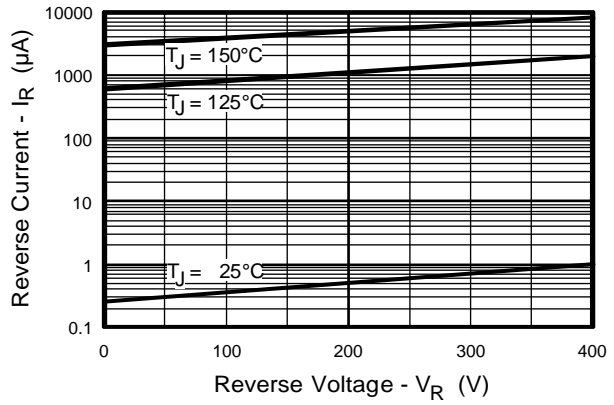
## Dynamic Recovery Characteristics (per Leg) @ $T_J = 25^\circ\text{C}$ (unless otherwise specified)

Parameter	Min.	Typ.	Max.	Units	Test Conditions	
$t_{rr}$ Reverse Recovery Time See Fig. 5	—	36	—	ns	$I_F = 1.0\text{A}, di_f/dt = 200\text{A}/\mu\text{s}, V_R = 30\text{V}$ $T_J = 25^\circ\text{C}$	
$t_{rr1}$	—	90	140			$T_J = 125^\circ\text{C}$
$t_{rr2}$	—	160	240			$T_J = 125^\circ\text{C}$
$I_{RRM1}$ Peak Recovery Current See Fig. 6	—	9.3	17	A	$T_J = 25^\circ\text{C}$ $T_J = 125^\circ\text{C}$	
$I_{RRM2}$	—	15	30			$T_J = 125^\circ\text{C}$
$Q_{rr1}$ Reverse Recovery Charge See Fig. 7	—	420	1100	nC	$T_J = 25^\circ\text{C}$ $T_J = 125^\circ\text{C}$	
$Q_{rr2}$	—	1200	3200			$T_J = 125^\circ\text{C}$
$di_{(rec)M}/dt1$ Peak Rate of Fall of Recovery Current $di_{(rec)M}/dt2$ During $t_b$ See Fig. 8	—	360	—	A/ $\mu\text{s}$	$T_J = 25^\circ\text{C}$ $T_J = 125^\circ\text{C}$	
	—	260	—			

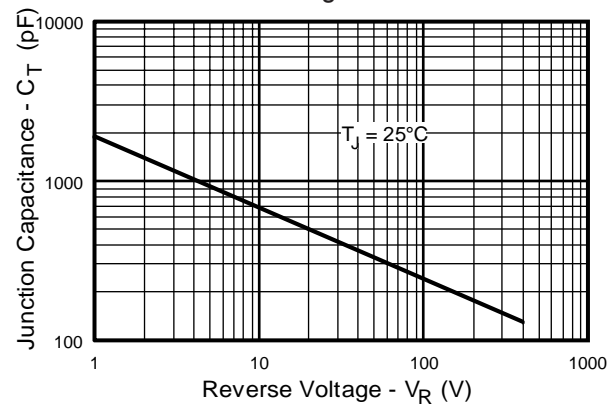




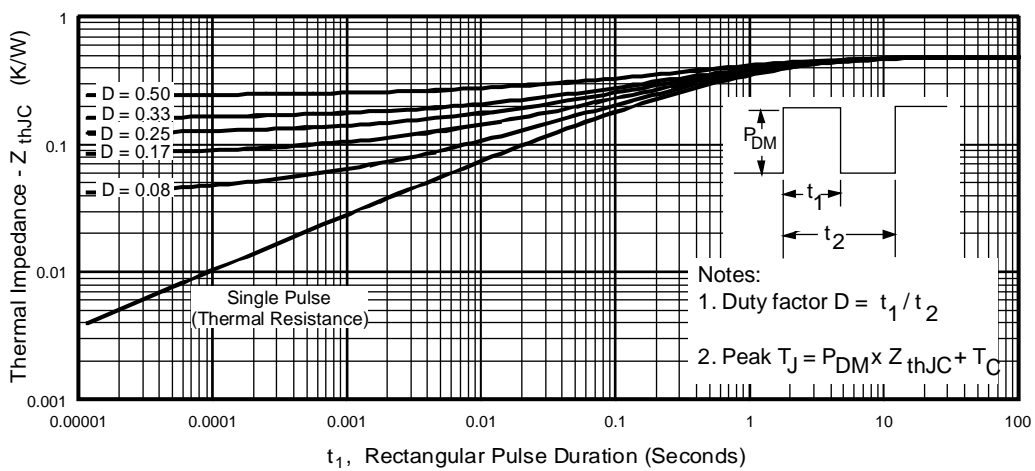
**Fig. 1** - Maximum Forward Voltage Drop vs. Instantaneous Forward Current



**Fig. 2** - Typical Reverse Current vs. Reverse Voltage



**Fig. 3** - Typical Junction Capacitance vs. Reverse Voltage



**Fig. 4** - Maximum Thermal Impedance  $Z_{thJC}$  Characteristics

# HFA90NH40R

PD-2.469 rev. B 02/99

International  
IOR Rectifier

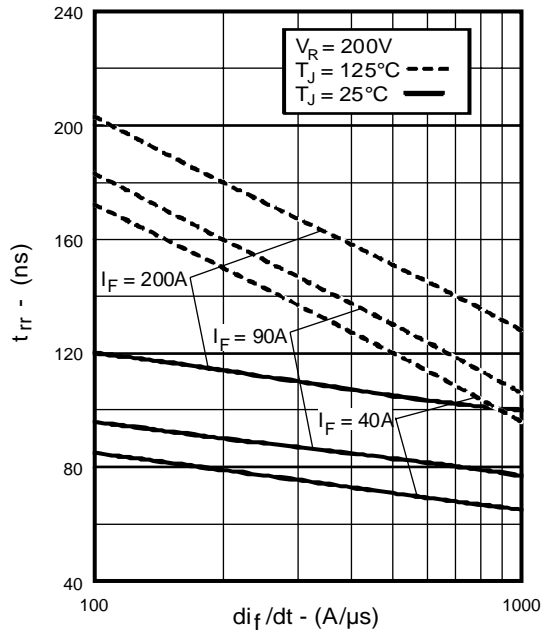


Fig. 5 - Typical Reverse Recovery vs.  $di_f/dt$

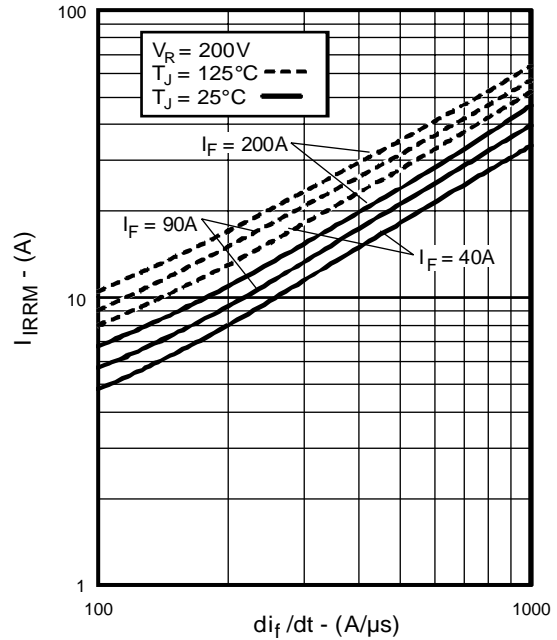


Fig. 6 - Typical Recovery Current vs.  $di_f/dt$

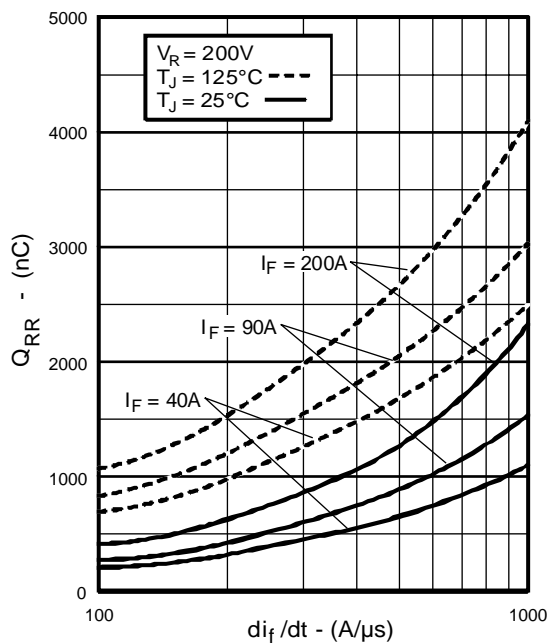


Fig. 7 - Typical Stored Charge vs.  $di_f/dt$

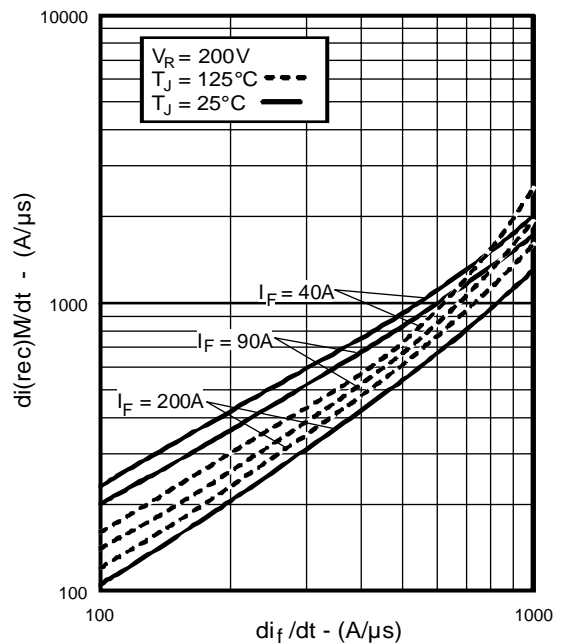
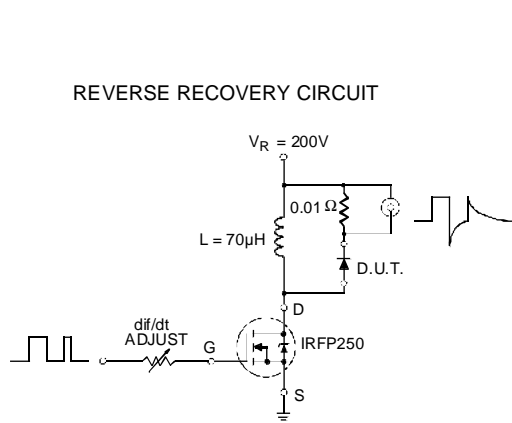
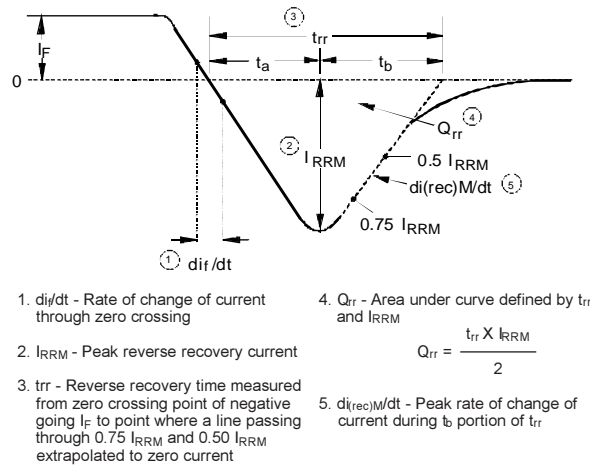


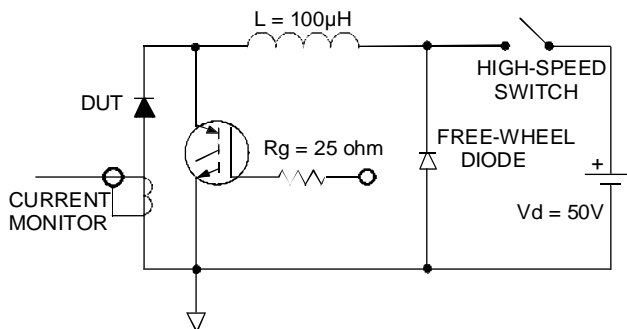
Fig. 8 - Typical  $di_{(rec)M}/dt$  vs.  $di_f/dt$



**Fig. 9** - Reverse Recovery Parameter Test Circuit



**Fig. 10** - Reverse Recovery Waveform and Definitions



**Fig. 11** - Avalanche Test Circuit and Waveforms

**WORLDHEADQUARTERS:** 233 Kansas St., El Segundo, California 90245 U.S.A. Tel: (310) 322 3331. Fax: (310) 322 3332.  
**EUROPEAN HEADQUARTERS:** Hurst Green, Oxted, Surrey RH8 9BB, U.K. Tel: ++ 44 1883 732020. Fax: ++ 44 1883 733408.  
**IR CANADA:** 15 Lincoln Court, Brampton, Markham, Ontario L6T3Z2. Tel: (905) 453 2200. Fax: (905) 475 8801.  
**IR GERMANY:** Saalburgstrasse 157, 61350 Bad Homburg. Tel: ++ 49 6172 96590. Fax: ++ 49 6172 965933.  
**IR ITALY:** Via Liguria 49, 10071 Borgaro, Torino. Tel: ++ 39 11 4510111. Fax: ++ 39 11 4510220.  
**IR FAR EAST:** K&H Bldg., 2F, 30-4 Nishi-Ikebukuro 3-Chome, Toshima-Ku, Tokyo, Japan 171. Tel: 81 3 3983 0086.  
**IR SOUTHEAST ASIA:** 1 Kim Seng Promenade, Great World City West Tower, 13-11, Singapore 237994. Tel: ++ 65 838 4630.  
**IR TAIWAN:** 16 Fl. Suite D.207, Sec. 2, Tun Haw South Road, Taipei, 10673, Taiwan. Tel: 886 2 2377 9936.